

DMIclassic Family

Operating Manual

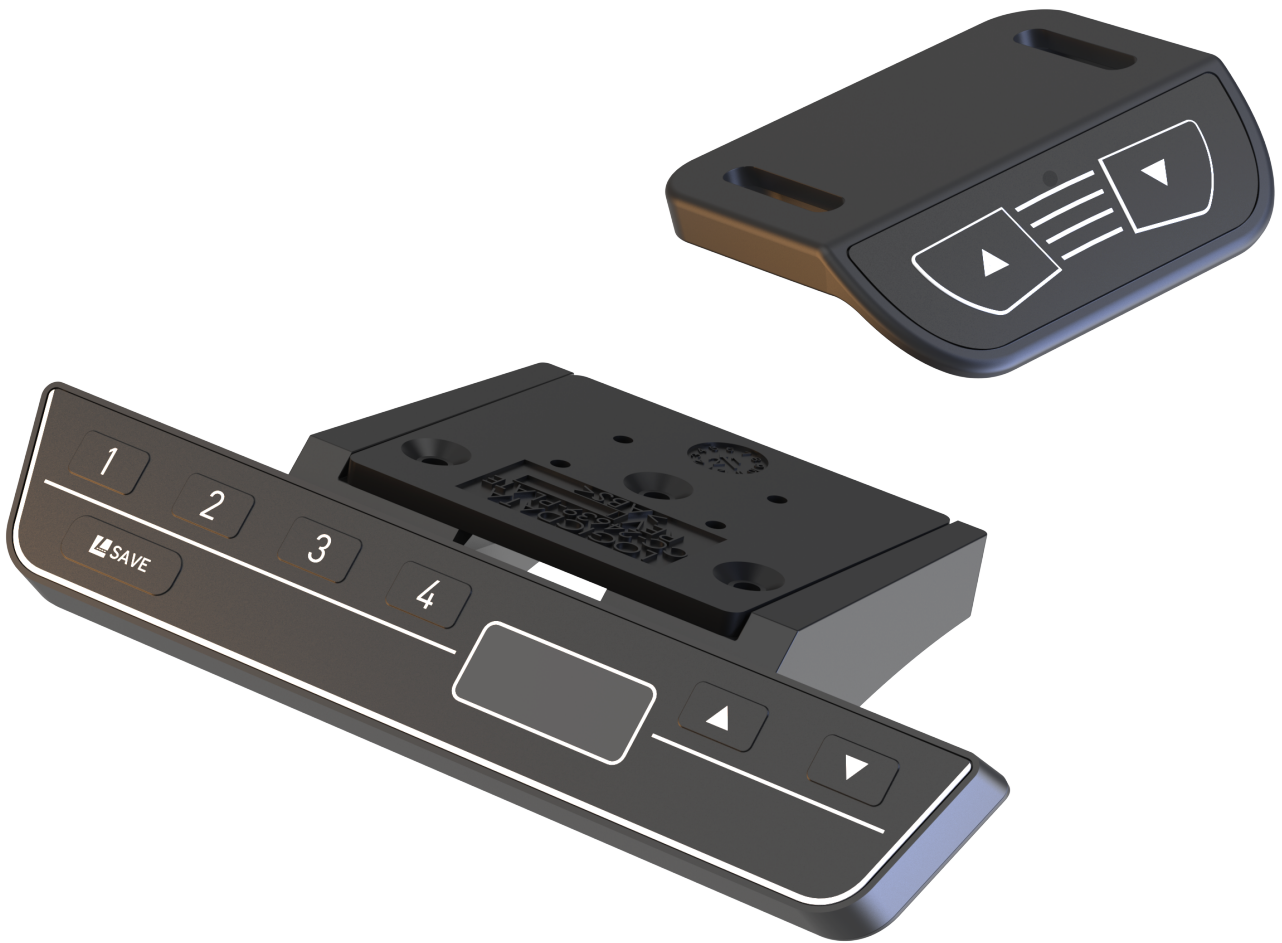



DMIconic Family - Operating Manual

Document Version 1.0 / September 2023

This document was originally published in English.

LOGICDATA Electronic & Software Entwicklungs GmbH

Wirtschaftspark 18
8530 Deutschlandsberg
Austria

Phone: +43 (0) 3462 51 98 0
Fax: +43 (0) 3462 51 98 1030
Internet: www.logicdata.net
Email: office.at@logicdata.net



CONTENTS

1	General Information	5
1.1	Other Applicable Documents	5
1.2	Copyright	5
1.3	Royalty-Free Use of Images and Text	5
1.4	Trademarks	5
2	Safety	6
2.1	Target Audience	6
2.2	General Safety Regulations	6
2.3	Intended Use	6
2.4	Reasonably Foreseeable Misuse	6
2.5	Explanation of Symbols and Signal Words	7
2.6	Liability	7
2.7	Residual Risks	8
2.8	Skilled Persons	9
2.9	Notes for Resellers	9
3	Scope Of Delivery	10
4	Unpackaging	10
5	Product	11
5.1	Key Product Features	11
5.1.1	DMIconic B	11
5.1.2	DMIconic C	12
5.1.2.1	About the Sliding Mechanism	12
5.2	Dimensions	13
5.2.1	DMIconic B	13
5.2.2	DMIconic C	14
5.3	Drilling Template	15
5.3.1	DMIconic B	15
5.3.2	DMIconic C	16
6	Assembly	17
6.1	Safety During Assembly	17
6.2	Required Components	18



6.3	Process	18
6.4	Completing Assembly	18
7	System Information	19
7.1	DMIconic B	19
7.2	DMIconic C	20
8	Operation	22
8.1	Adjusting the Table Top Height	23
8.2	Saving a Memory Position (DMIconic C Only)	23
8.3	Adjusting the Table to a Memory Position (DMIconic C Only)	24
8.4	Changing the Height Display (cm/inch, DMIconic C Only)	25
9	Additional Information	25
9.1	Disassembly	25
9.2	Maintenance	26
9.2.1	Cleaning	26
9.3	Troubleshooting	26
9.4	Disposal	26



1 GENERAL INFORMATION

Documentation for the DMIClassic Family Handset consists of this Operating Manual and several other documents (Other applicable documents, page 5). Assembly personnel must read all documentation before starting assembly. Keep all documentation for as long as the product is in your possession. Ensure that all documentation is provided to subsequent owners. Go to www.logicdata.net for more information and support. This Manual may change without notice. The most recent version is available on our website.

1.1 OTHER APPLICABLE DOCUMENTS

This Operating Manual contains assembly and operation instructions for the DMIClassic Family Handset. Other applicable documents include:

- Datasheet for DMIClassic Handset
- DYNAMIC MOTION System Manual
- Datasheet and Operating Manual for the installed DYNAMIC MOTION Actuator
- Datasheet for the installed Power Unit

1.2 COPYRIGHT

© September 2023 by LOGICDATA Electronic und Software Entwicklungs GmbH. All rights reserved, except for those listed in Chapter 1.3 Royalty-free use of images and text on page 5.

1.3 ROYALTY-FREE USE OF IMAGES AND TEXT

After purchase and full payment of the product, all text and images in Chapter 2 “Safety”, may be used free of charge by the customer for 10 years after delivery. They should be used to prepare end user documentation for Height-Adjustable Table Systems. The license does not include logos, designs, and page layout elements belonging to LOGICDATA. The Reseller may make any necessary changes to the text and images to adapt them for the purpose of end user documentation. Texts and images may not be sold in their current state and may not be published or sublicensed digitally. The transfer of this license to third parties without permission from LOGICDATA is excluded. Full ownership and copyright of the text and graphics remain with LOGICDATA. Texts and graphics are offered in their current state without warranty or promise of any kind. Contact LOGICDATA to obtain text or images in an editable format (documentation@logicdata.net).

1.4 TRADEMARKS

Documentation may include the representation of registered trademarks of goods or services, as well as information about copyright or other proprietary expertise of LOGICDATA or third parties. In all cases, all rights remain exclusively with the respective copyright holder. LOGICDATA® is a registered trademark of LOGICDATA Electronic & Software GmbH in the USA, the European Union, and other countries.



2 SAFETY

2.1 TARGET AUDIENCE

This Operating Manual is intended for Skilled Persons only. Refer to Chapter 2.8 Skilled Persons on page 9 to ensure that personnel meet all requirements.

2.2 GENERAL SAFETY REGULATIONS

In general, the following safety regulations and obligations apply when handling the product:

- Do not operate the product unless it is in a clean and perfect condition
- Do not remove, change, bridge, or bypass any protection, safety, or monitoring equipment
- Do not convert or modify any components without written approval from LOGICDATA
- In the event of malfunction or damage, faulty components must be replaced immediately
- Unauthorized repairs are prohibited
- Do not attempt to replace hardware unless the product is in a de-energized state
- Only Skilled Persons are allowed to work with DMIClassic Family handsets
- Ensure that national worker protection conditions and national safety and accident prevention regulations are observed during operation of the system

2.3 INTENDED USE

The products in the DMIClassic Family Handset are for electrically Height-Adjustable Tables. They are installed by Resellers into Height-Adjustable Table systems. They are used to control Height-Adjustable Table systems via an integrated Control Unit in the connected DYNAMIC MOTION Actuator. They are intended for indoor use only. They may only be installed in compatible Height-Adjustable Table Systems and with LOGICDATA-approved accessories. Contact LOGICDATA for further details. Use beyond or outside the intended use will void the product's warranty.

2.4 REASONABLY FORESEEABLE MISUSE





Usage outside of the intended use may lead to minor injury, serious injury, or even death. Reasonably foreseeable misuse of the Handset includes, but does not extend to:

- Connecting unauthorized parts to the product. If you are unsure as to whether a part can be used with a Handset, contact LOGICDATA for further information



2.5 EXPLANATION OF SYMBOLS AND SIGNAL WORDS

Safety Notices contain both symbols and signal words. The signal word indicates the severity of the hazard.

	DANGER	Indicates a hazardous situation which, if not avoided, will result in death or serious injury.
	WARNING	Indicates a hazardous situation which, if not avoided, could result in death or serious injury.
	CAUTION	Indicates a hazardous situation which, if not avoided, could result in minor or moderate injury.
	NOTICE	Indicates a situation which, if not avoided, could result in damage to the product through electrostatic discharge (ESD).
	NOTICE	Indicates a situation that will not lead to personal injury, but could lead to damage to the device or the environment.
	INFO	Indicates the protection class of the device: Protection Class III. Protection Class III devices may only be connected to SELV or PELV power sources.
	INFO	Indicates important tips for handling the product.

2.6 LIABILITY

LOGICDATA products comply with all currently applicable health and safety regulations. However, risk can result from incorrect operation or misuse. LOGICDATA is not liable for damage or injury caused by:

- Improper product use
- Disregard of the documentation
- Unauthorized product alterations
- Improper work on and with the product
- Operation of damaged products
- Wear parts
- Improperly performed repairs
- Unauthorized changes to the operating parameters
- Disasters, external influence, and force majeure

The information in this Operating Manual describes the characteristics of the product without assurances. Resellers assume responsibility for the LOGICDATA products installed in their applications. They must ensure their product complies with all relevant directives, standards, and laws. LOGICDATA shall not be held liable for any damage that is directly or indirectly caused by the delivery or use of this document. Resellers must observe the relevant safety standards and guidelines for each product in the Table System.



2.7 RESIDUAL RISKS

Residual risks are the risks that remain after all relevant safety standards have been complied with. These have been evaluated in the form of a risk assessment. Residual risks associated with the installation of the DMIClassic Family handsets are listed here and throughout this Operating Manual. The risks associated with the system as a whole are listed in the System Manual. See also Chapter 1.1 Other Applicable Documents on page 5. The symbols and signal words used in this Operating Manual are listed in Chapter 2.5 Explanation of Symbols and Signal Words on page 7.



WARNING Risk of death or serious injury through electric shocks

DMIClassic Family handsets are electrical devices. Although you will not have to connect any products to the Power Unit during assembly, basic safety precautions must be taken at all times. Failure to observe electrical safety precautions may lead to death or serious injury through electric shocks.

- Never open the Handset
- Do not convert or modify the Handset in any way
- Do not immerse the Handset or its components in liquid. Clean only with a dry or slightly damp cloth
- Do not place the Cable of the Handset on heated surfaces
- Check the housing and cables of the Handset for visible damage. Do not install or operate damaged products



WARNING Risk of death or serious injury through electric shocks

The DMIClassic Family handsets are Protection Class III devices. They may only be supplied with safety extra-low voltage (SELV). Supplying the DMIClassic Family handsets with the incorrect voltage could result in death or serious injury through electric shocks.

- Only supply the DMIClassic Family handset with safety extra-low voltage (SELV)
- Refer to the data sheet for information on the permissible supply voltage



WARNING Risk of death or serious injury in explosive atmospheres

Operating the Handset in potentially explosive atmospheres may lead to death or serious injury through explosions.

- Do not operate the Handset in potentially explosive atmospheres



CAUTION Risk of minor or moderate injury through tripping

During the assembly process, you may have to step over Cables. Tripping over Cables may lead to minor or moderate injury.

- Ensure that the assembly area is kept clear of unnecessary obstructions
- Be careful not to trip over Cables



⚠ CAUTION Risk of minor or moderate injury through crushing

If any Handset Key becomes stuck while the system is in motion, the system may not stop properly. This may lead to minor or moderate injury through crushing.

- Disconnect the system immediately if any Handset Key becomes stuck

2.8 SKILLED PERSONS

DMiclassic Family handsets may only be installed by Skilled Persons. A Skilled Person is defined as someone who:

- Has read and understood all documentation relevant to the Handset

2.9 NOTES FOR RESELLERS

Resellers are companies that purchase LOGICDATA products for installation in their own products.

INFO For reasons of EU conformity and product safety, Resellers should provide end users with an Operating Manual in their native EU official language

INFO The Charter of the French Language (La charte de la langue française) or Bill 101 (Loi 101) guarantees the right of the population of Quebec to conduct business and commercial activities in French. The bill applies to all products sold and used in Quebec. For table systems that will be sold or used in Quebec, Resellers must provide all product-relevant texts in French. These include, but are not limited to

- Operating Manuals
- All other product documentation, including datasheets
- Inscriptions on the product (such as labels), including those on product packaging
- Warranty certificates

The French inscription may be accompanied with a translation or translations, but no inscription in another language may be given greater prominence than that in French.

INFO Operating Manuals must include all the safety instructions that end users require to handle the product safely. They must also include an instruction to always keep the Operating Manual in the immediate vicinity of the product.

INFO No unauthorized persons (young children, persons under the influence of medications, etc.) should be allowed to handle the product.

INFO Resellers must perform a risk assessment on their product that covers residual hazards. It must include measures to mitigate risk, or reference the product's Operating Manual.



3 SCOPE OF DELIVERY

The standard scope of delivery for Handsets in the DMiClassic Family consists of the Handset, its preattached cable (and 3 mounting screws only in case DMiClassic C). All other components necessary for installing the Handset must be supplied separately by the reseller.

4 UNPACKAGING

To unpackage the product:

1. Remove all components from the packaging
2. Check the contents of the package for completeness and damage
3. Provide the Operating Manual to the operating personnel
4. Dispose of the packaging material

NOTICE Dispose of the packaging material in an environmentally friendly manner. Remember to separate plastic parts from the cardboard packaging.



NOTICE Ensure proper ESD handling during unpackaging. Damage that can be attributed to electrostatic discharge will void warranty claims.



5 PRODUCT

The DMiClassic Family of Handsets consists of two products: DMiClassic B and DMiClassic C. In general, operation and assembly of both handsets are similar with some differences that will be pointed out within this manual further on.

5.1 KEY PRODUCT FEATURES

5.1.1 DMICLASSIC B

1	Mounting Points
2	UP / DOWN Keys
3	LED Signal Light

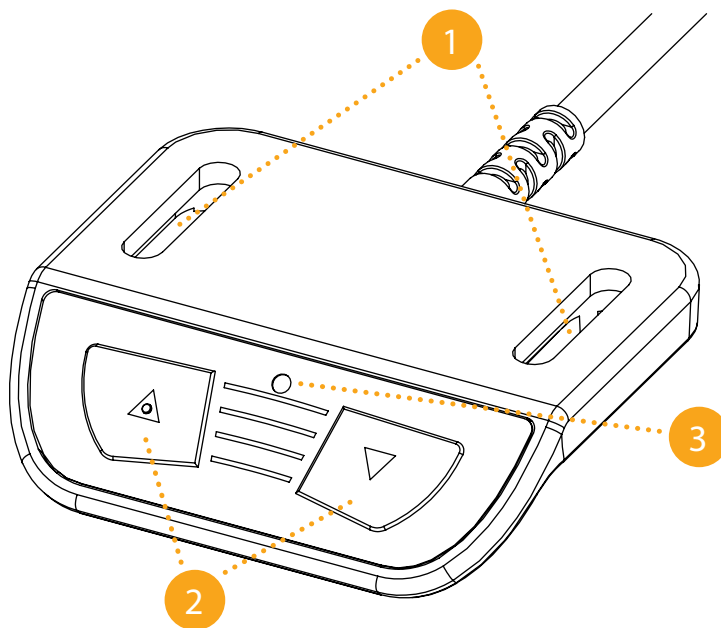

Fig. 1: Product features, DMiClassic B



5.1.2 DMICLASSIC C

1	Memory Position Keys
2	Mounting Points
3	UP / DOWN Keys
4	SAVE Key
5	Display
6	Mounting Plate (for sliding mechanism)

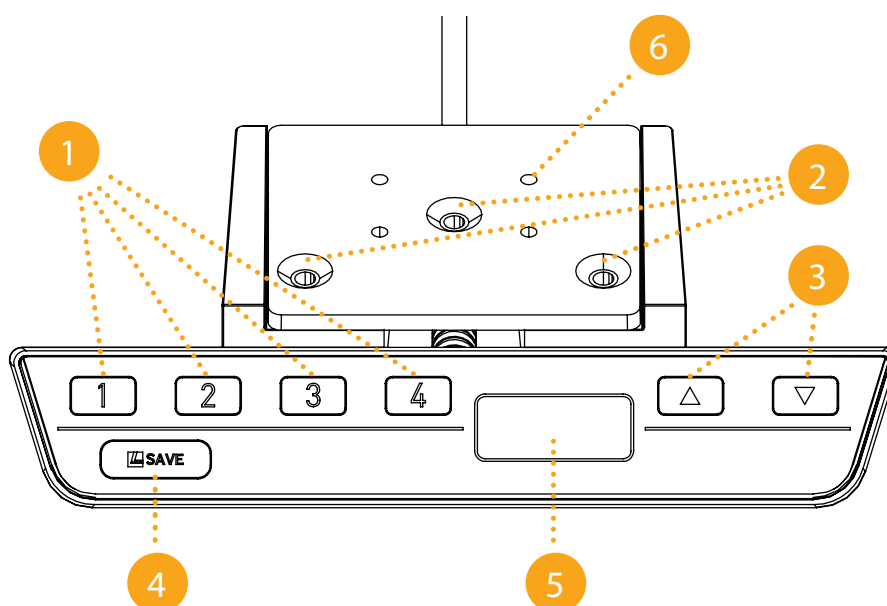

Fig. 2: Product features, DMIClassic C

5.1.2.1 ABOUT THE SLIDING MECHANISM

The Sliding Mechanism is a feature of DMIClassic C that allows the handset to be stowed under the table, during transportation or when it is not being used.

To move to the retracted position: Push the handset inwards toward the table top until it clicks into place.

To move to the extended position: Pull the handset outwards until it clicks into place.



5.2 DIMENSIONS

5.2.1 DMICLASSIC B

Length	50.0 mm 1.967"
Width	59.9 mm 2.358"
Height (to underside of Table Top)	17.3 mm 0.681"

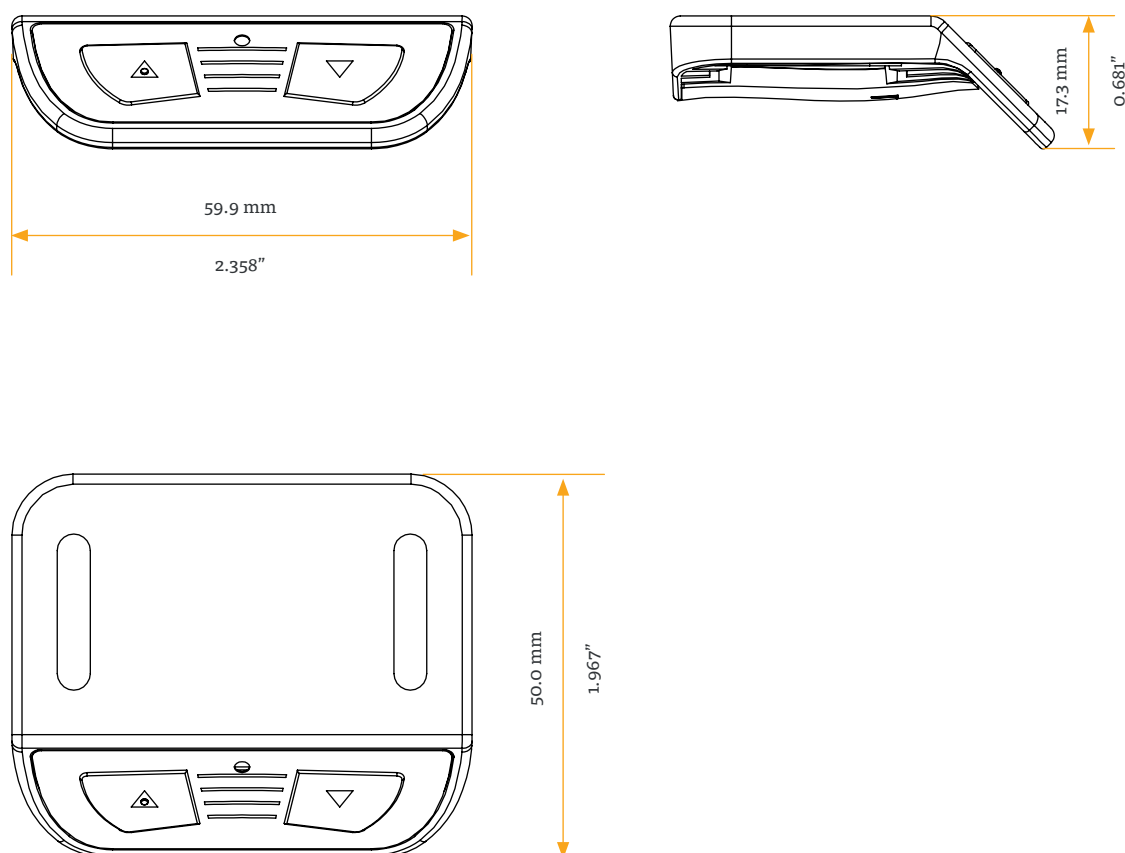

Fig. 3: Product dimensions, DMIClassic B



5.2.2 DMICLASSIC C

Length	69.5 mm 2.736"
Width	137.2 mm 5.404"
Height (to underside of Table Top)	24.7 mm 0.974"

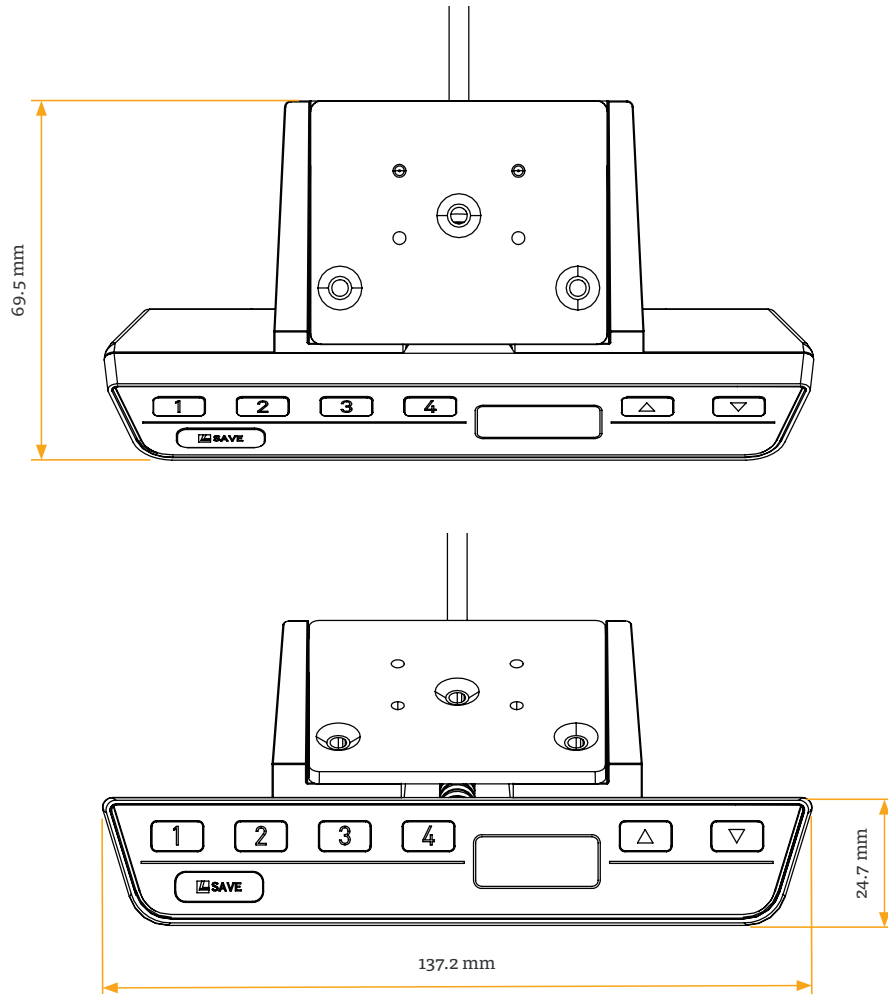

Fig. 4: Product dimensions, DMIClassic C



5.3 DRILLING TEMPLATE

5.3.1 DMICLASSIC B

There are two variants for mounting. In the Standard Position the drilled holes should be 8 mm from the front edge of the Table Top and 43.8 mm apart.

Alternatively, the drilled holes can be set to the Transportation Position, 24 mm from the front edge of the Table Top and 43.8 mm apart. The Transportation Position allows the DMiClassic B to be slid backwards underneath the Table Top, so that the Handset does not protrude from the front edge of the table when in transport.

The Side Edge of the DMiClassic B does not have to be flush with the Table's Side Edge. Leave a minimum of 20 mm between the outer hole and the Side Edge to ensure the DMiClassic B does not protrude from the side

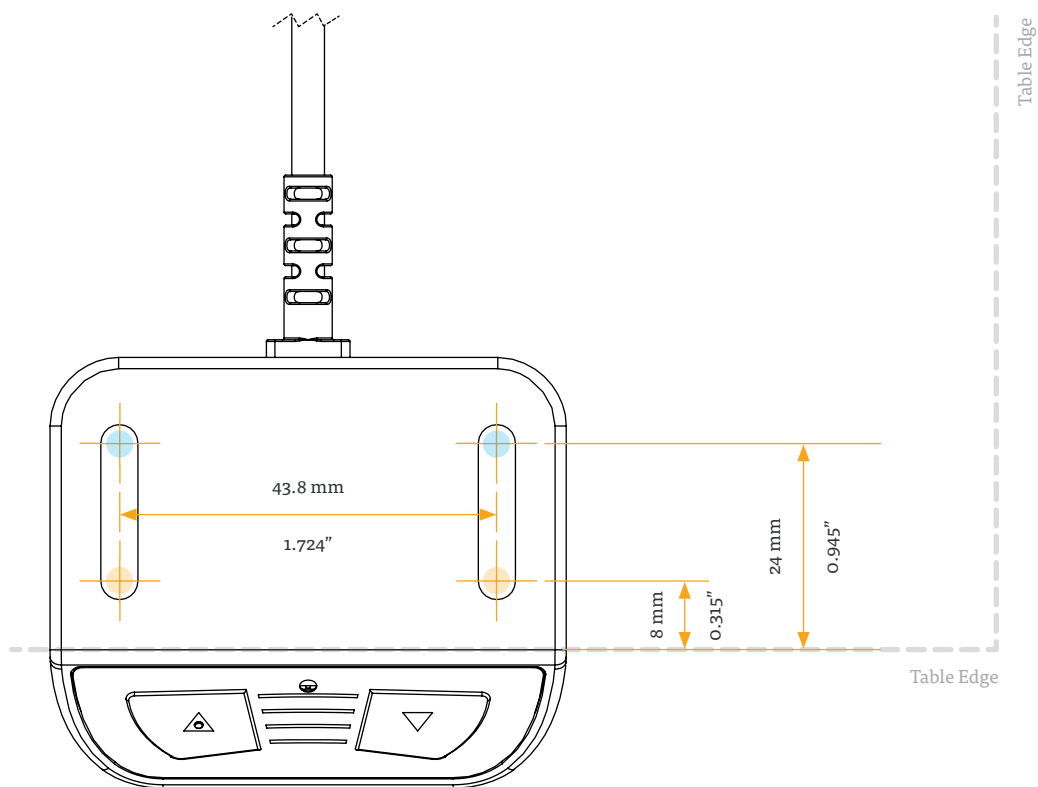

●	Transportation Position
●	Standard Position

Fig. 5: Drilling template, DMiClassic B



5.3.2 DMICLASSIC C

When placing the drilling holes, it must be ensured that the Handset does not protrude from the front edge of the Table Top while in the retracted position. To ensure the correct position:

- The two drilling holes at the front of the plate must be 31.5 mm from the front edge of the table.
- The two drilling holes must be placed in a line parallel to the front edge of the table and 46 mm apart.
- The single drilling hole at the back of the plate must be 45.5 mm from the front edge of the table.
- The center of the single drilling hole must be 23 mm from the width of each of the two front holes.

The Side Edge of the DMiClassic C handset does not have to be flush with the Table's Side Edge. To avoid protrusion over the side edge, leave a gap of at least 70 mm from the central hole to the side edge of the table.

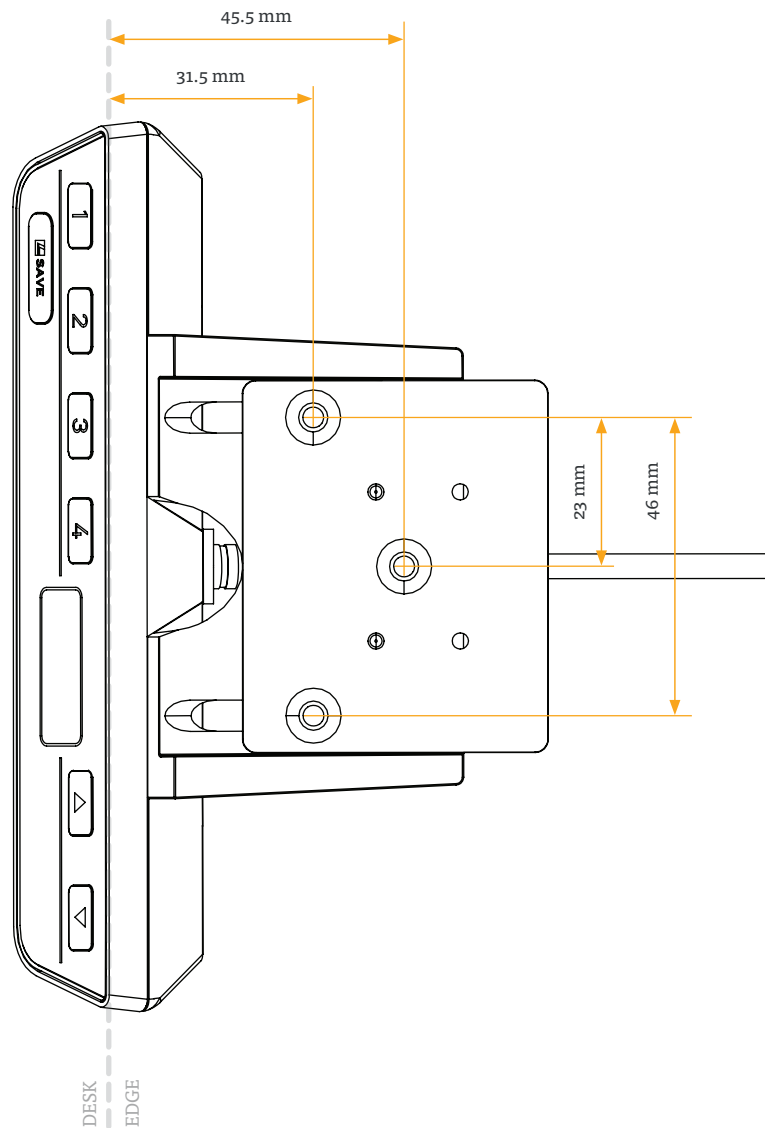

Fig. 6: Drilling template, DMiClassic C



6 ASSEMBLY

This chapter describes the process of installing the DMiClassic Family handset into the DYNAMIC MOTION System.

6.1 SAFETY DURING ASSEMBLY

-
- ⚠ WARNING** **Risk of death or serious injury through electric shocks**
DMiClassic Family handsets are electrical devices. Basic safety precautions must be taken at all times. Failure to observe electrical safety precautions may lead to death or serious injury through electric shocks.
- Never open the Handset
 - Ensure that the Handset is not connected to the Power Unit during assembly
 - Do not convert or modify the Handset in any way
 - Check the housing and cables of the Handset for visible damage. Do not install or operate damaged products.
-

- ⚠ CAUTION** **Risk of minor or moderate injury through improper handling**
Improper handling of the product during assembly may lead to minor or moderate injury through cutting, pinching, and crushing.
- Avoid contact with sharp edges
 - Be careful while handling tools that may cause personal injury
 - Ensure assembly complies with the generally accepted standards and guidelines of electrical engineering and furniture manufacturing
 - Read all instructions and safety advice carefully
-

- ⚠ CAUTION** **Risk of minor or moderate injury through tripping**
During assembly and operation, poorly routed Cables may become a trip hazard. Tripping over Cables may lead to minor or moderate injury.
- Ensure that Cables are routed properly to avoid trip hazards
 - Be careful not to trip over Cables when installing the Handset
-

- ⚠ NOTICE** Ensure proper ESD handling during assembly. Damage that can be attributed to electrostatic discharge will void warranty claims.
-

NOTICE To avoid damage to the product, measure the dimensions of the Handset before assembly.

NOTICE Before assembly, all parts must be acclimatised to the ambient conditions.

NOTICE Do not lift the Handset by its cable. This will cause irreparable damage to the product.

INFO Perform a product risk assessment so that you can respond to potential residual hazards. Assembly instructions must be included in your end user Operating Manual.



6.2 REQUIRED COMPONENTS

1x	DMIconic Family handset
2x (DMIconic B) or 3x (DMIconic C)	Mounting Screws (for DMIconic B supplied by Reseller)
Tool	Drill or Drilling Machine
Tool	Screwdriver

INFO **Screw specifications for DMIconic B**
The mounting points have a width of 4.3 mm. The Mounting Screws should hold the Handset safely and securely in place. Exact specifications can be provided by LOGICDATA on request.

INFO **Screw Specifications for DMIconic C**
The Mounting Screws are provided by LOGICDATA with the Handset. These are 16 mm in length, with a 3 mm thread and 8 mm head diameter.

6.3 PROCESS

NOTICE DMIconic C handset is equipped with a sliding mechanism and should always be mounted in the retracted position.

1. Place the Handset into the rails of the sliding plate (applicable only for DMIconic C).
2. Position the Handset in the desired position under the table top and mark the position of the Mounting Points. For DMIconic C ensure that the Handset is in the retracted position and does not protrude from the edge of the Table Top.
3. Drill the holes for the Mounting Screws into the Table Top at the marked points.
4. Use the screwdriver and Mounting Screws to attach the Handset to the Table Top at the drilled holes.

NOTICE The required tightening torque depends on the material of the Table Top. Do not exceed 2 Nm.

6.4 COMPLETING ASSEMBLY

After the DMIconic Family handset is attached to the Table Top, you must connect the Cable to the Power Hub. Refer to the manual for your chosen Power Hub for instructions.



7 SYSTEM INFORMATION

7.1 DMICLASSIC B

When a DMIClassic B Handset is installed alongside the DYNAMIC MOTION system, system information is communicated via flashes of the LED Signal Light. Possible signals are as follows:





SIGNAL	MESSAGE	REQUIRED ACTIONS
No Light	System operating normally	Operate the DM System as normal
	System not connected properly	See Chapter 4 for connection instructions
Red Light Blinking	System Error Warning	Release all keys and wait for 5 seconds. Then try to repeat the action again. Disconnect all components from the Power Hub.
		Disconnect the Power Hub from the Mains. Check the Power Hub for overheating. Let cool if necessary.
		Check all cable connections and reconnect the system.
		If problem persists: Perform a Position Reset Procedure (Chapter 4.7). Contact LOGICDATA.
Green Light Blinking	System Start-up	Wait until the LED has stopped blinking to continue. Do not press any buttons.
	Reset in Progress	
	Duty Cycle Exceeded	
	Collision Detected (ISP)	
Green Light Flashing Rapidly	Position Reset Required.	Perform a Position Reset Procedure (System Manual, Chapter 4.7).

NOTICE Do not operate the DYNAMIC MOTION system if problems persist. Contact LOGICDATA for further information.



7.2 DMICLASSIC C

When a DMiClassic C Handset is installed alongside the DYNAMIC MOTION system, error messages are displayed on the digital display panel. These are as follows:

SIGNAL	MESSAGE	REQUIRED ACTIONS
 The display shows "Hot".	Overheating protection has been activated.	Wait for the overheated components to cool.
 The display shows "ISP".	The system has recognized a collision.	Release all Keys and wait for the Drive Back function to be completed.
 The display shows "Con".	The system has recognized a connection error.	Release all Keys and wait for 5 seconds. Then, try again. Disconnect the Power Unit from the Mains. Then, disconnect System from the Power Unit. Reconnect the system again, then operate the DM System as normal.
 Handset displays error code "CXX" (e.g. C17).	An internal error has occurred.	Read the table below to find the correct response to the error code shown.



CODE	MESSAGE	REQUIRED ACTIONS
1	Firmware Error	Disconnect the Power Unit from the Mains. Then, disconnect System from the Power Unit. Reconnect the system again, then operate the DM System as normal.
2	Motor Over Current	Release all Keys and wait for 5 seconds. Then, try again.
3	DC Over Voltage	Release all Keys and wait for 5 seconds. Then, try again.
8	Impulse Detection Timeout	Perform a Position Reset Procedure (see System Manual)
11	Speed cannot be achieved	Release all Keys and wait for 5 seconds. Then, try again.
12	Power Stage Overcurrent	Release all Keys and wait for 5 seconds. Then, try again.
13	DC Under Voltage	Release all Keys and wait for 5 seconds. Then, try again.
14	Out of Sync	Release all Keys and wait for 5 seconds. Then, try again.
15	Strain Gauge is defective	Release all Keys and wait for 5 seconds. Then, try again. Contact LOGICDATA if the problem persists. Do not operate the DM System if components are broken.
17	Error during pairing sequence	Disconnect the Power Unit from the Mains. Then, disconnect System from the Power Unit. Reconnect the system again, then operate the DM System as normal. If this fails, perform a factory reset (see DM System Manual).
18	Parameterization or firmware of different Actuators in the Table System are incompatible.	Re-parameterize the Actuators. Contact LOGICDATA for further information.
19	Too many / too few Actuators connected	Connect the correct number of Actuators (as specified in setup).









20	Motor short circuit and/or open load	Contact LOGICDATA.
21	Firmware Error	Disconnect the Power Unit from the Mains. Then, disconnect System from the Power Unit. Reconnect the system again, then operate the DM System as normal.
22	Power Unit overload	Release all Keys and wait for 5 seconds. Then, try again.
23	Motor Under Voltage	Release all Keys and wait for 5 seconds. Then, try again.
28	External Collission Sensor Error	Disconnect the Power Unit from the Mains and check cable connections.

NOTICE Do not operate the DYNAMIC MOTION system if problems persist. Contact LOGICDATA for further information.

8 OPERATION

Instructions for operating the system can be found in the DYNAMIC MOTION System Manual. A list of core features can be found below. Handset Keys are represented as follows for further description:

	UP Key
	DOWN Key
	SAVE Key (DMIclassic C only)
	Memory Position Key 1 (DMIclassic C only)
	Memory Position Key 2 (DMIclassic C only)
	Memory Position Key 3 (DMIclassic C only)
	Memory Position Key 4 (DMIclassic C only)



8.1 ADJUSTING THE TABLE TOP HEIGHT

- ⚠ CAUTION Risk of minor or moderate injury through crushing**
Your fingers may be crushed when you attempt to change the height of the table.
- Keep fingers away from moving parts
 - Ensure that no persons or objects are in the table's range of motion

INFO The Table Top will move up or down until the UP or DOWN Key is released, or if a pre-defined stopping point has been reached.

To move the Table Top UP:



Press and hold the UP Key until the desired height has been reached

To move the Table Top DOWN:



Press and hold the DOWN Key until the desired height has been reached

8.2 SAVING A MEMORY POSITION (DMICLASSIC C ONLY)

This function saves a set Table Top position. One Memory Position can be saved per Memory Position Key.

	1. Move the table to the desired height
	▶ The display shows the Table Top height (e.g. 73 cm)
	2. Press the SAVE Key
	▶ The display shows S-
	3. Press the Memory Position Key (e.g. 2)
	▶ The display shows S 2
	▶ After about two seconds, the Table Top height is displayed again



8.3 ADJUSTING THE TABLE TO A MEMORY POSITION (DMICLASSIC C ONLY)

Version A (without double-click function):

2	1. Press and hold the required Memory Position Key (e.g. 2).
	▶ The Table Top will move until the saved Table Top height has been reached. If you release the Key before the Memory Position is reached, the table will stop.
2	2. Release the Memory Position Key
73	▶ The display shows the Table Top height (e.g. 73 cm)

Version B (Auto-Movement with double-click function):

INFO	The double-click function is available only for DM Systems sold in US markets.
INFO	If you press any Key while the table moves to a Memory Position, the Table Top will stop moving immediately. To continue, you must select the Memory Position again.
! WARNING	<p>Risk of minor or moderate injury through unauthorized modifications</p> <p>The control system firmware is supplied in Europe with the double-click function disabled. After enabling this functionality the safety of the end product must be evaluated.</p> <ul style="list-style-type: none"> • A risk assessment to demonstrate conformity to the requirements of Machinery Directive 2006/42/EC is required prior to use. • LOGICDATA is not liable for injuries or damage caused by activating the double-click function
2	1. Double-click the required Memory Position Key (e.g. 2)
	▶ The table will move to the Memory Position. You do not have to hold the Key
73	▶ The display shows the Table Top height (e.g. 73 cm)



8.4 CHANGING THE HEIGHT DISPLAY (CM/INCH, DMICLASSIC C ONLY)

DMiclassic C Handsets can display the height of the Table Top in both centimeters and inches. To change the displayed unit of measurement:

	<ol style="list-style-type: none"> 1. Press and hold Memory Position Keys 1 and 2, alongside the UP Key
	<ul style="list-style-type: none"> ▶ The display shows S and a number, e.g. S 7.
	<ol style="list-style-type: none"> 2. Press the UP Key or DOWN Key until the display shows S 5.
	<ul style="list-style-type: none"> ▶ The display shows S 5.
	<ol style="list-style-type: none"> 3. Press the SAVE Key <ul style="list-style-type: none"> ▶ If the display was previously set to cm, it is now set to inches. ▶ If the display was previously set to inches, it is now set to cm.

9 ADDITIONAL INFORMATION

9.1 DISASSEMBLY

To disassemble the DMiclassic Family handset, ensure that it has been disconnected from the Power Unit. Then, follow the assembly instructions for your chosen product in reverse order.



9.2 MAINTENANCE

All DMIClassic Family Handsets are maintenance-free for their entire service lifetime.

WARNING Risk of death or serious injury through electric shocks and other hazards

Using a DMIClassic Family Handset alongside unauthorized spare or accessory parts may lead to death or serious injury through electric shocks and other hazards.

- Only use accessory parts produced or approved by LOGICDATA
- Only use replacement parts produced or approved by LOGICDATA
- Only allow Skilled Persons to perform repairs or install accessory parts
- Contact customer services immediately if the system malfunctions

The use of unauthorized spare or accessory parts may cause system damage. Warranty claims are void in this scenario.

9.2.1 CLEANING

1. Disconnect the system from the Power Unit.
2. Wait 30 seconds for residual voltage to dissipate.
3. Wipe the surface of the Handset with a dry or slightly damp soft cloth. Never immerse the Handset in liquid.
4. Wait for the Handset to dry completely.
5. Reconnect the Power Unit.

9.3 TROUBLESHOOTING

A list of common problems and their solutions can be found in the DYNAMIC MOTION System Manual. Most errors with DMIClassic Family handsets occur when the Control Panel is touched during calibration. Such errors can be avoided by waiting for 10 seconds to use the Control Panel after start-up. If your DMIClassic Family handsets are not functioning, a reset may be required. To reset, proceed as follows:

1. Unplug the DMIClassic Family handset from the Power Unit
2. Wait for 10 seconds.
3. Plug the DMIClassic Family handset back into the Power Unit.
4. Wait for 10 seconds.
 - ▶ The DMIClassic Family handset is ready for operation.

9.4 DISPOSAL



Dispose of all components separately from household waste. Use designated collection points or disposal companies authorized for this purpose.



LOGICDATA
Electronic & Software Entwicklungs GmbH
Wirtschaftspark 18
8530 Deutschlandsberg
Austria

Phone: +43 (0)3462 5198 0
Fax: +43 (0)3462 5198 1030
E-mail: office.at@logicdata.net
Internet: <http://www.logicdata.net>

LOGICDATA North America, Inc.
13617 Woodlawn Hills Dr.
Cedar Springs, MI 49319
USA

Phone: +1 (616) 328 8841
E-mail: office.na@logicdata.net



www.logicdata.net